

# T100 & T150 Chain Openers



## » T100

The most popular type of window opener with 250mm travel. Can be used on most window styles and materials with the appropriate fixing brackets (see page 7).

The T100 can control individual or multiple sets of windows from a single operator (see pages 8, 9)

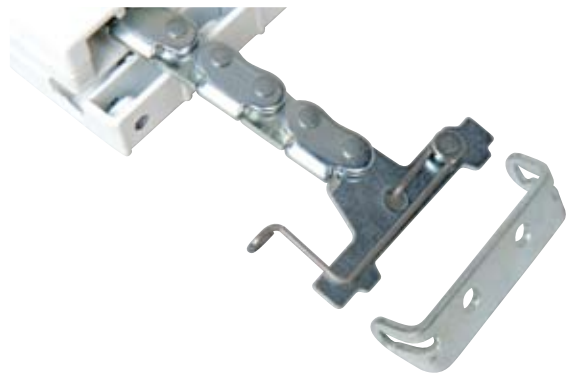

*T100 Vent Bracket*

## » T150

Similar to the T100 but with 380mm travel. The T150 cannot be used with the T250 operator.

### » Standard Colours

**White (RAL 9010)**

**Black (RAL 9005)**

**Grey (RAL 9006)**



*T100 Manual Operation*

# T100 & T150 Chain Openers

## » Fitting Notes

### T100

- For the full 250mm travel the vent must be 500mm high.

### T150

- For the full 380mm travel the vent must be 900mm high.
- Travel on chain openers fitted to shallower windows must be restricted to 30% of vent height using T700 spring stops or T720 square nuts to shorten cable travel. All bottom-hung open-in applications require a minimum of 50mm head clearance.





**PLEASE NOTE:** For safety reasons we recommend fitting side support stays to all bottom-hung, open-in windows.

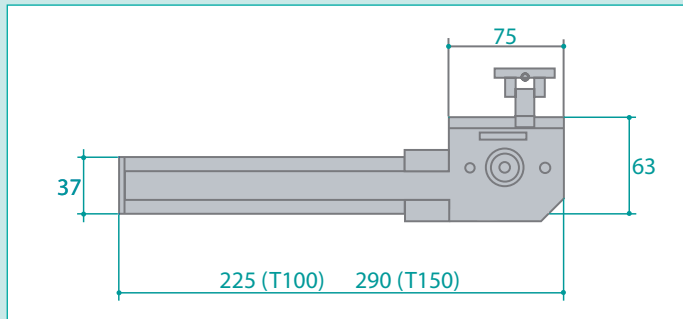

T100 colour variations

## » Accessories & Tools

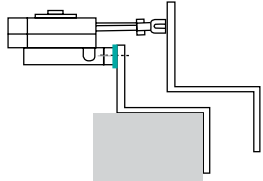
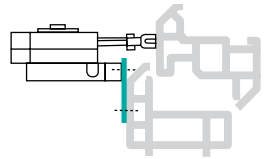
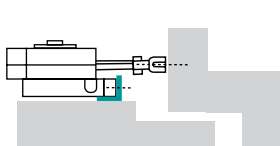
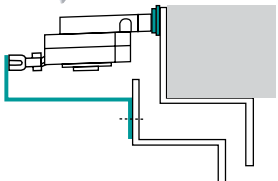

T740 Narrow Fixing Plate	T750 Wide Fixing Plate	T760 Angled Fixing Plate	T850 Bottom-Hung Fixing Kit
For surface fixing the chain opener to aluminium windows. Available in white, black or grey.	For surface fixing chain opener to PVCu windows. Available in white, black or grey.	For surface fixing chain opener to timber window sills. Available in white, black or grey.	Set of frame and vent brackets for fitting chain openers to bottom hung, open in windows. Available in white, black or grey.
			
			
T740	T750	T760	T850